

Art. Nr. 2810296

1/6

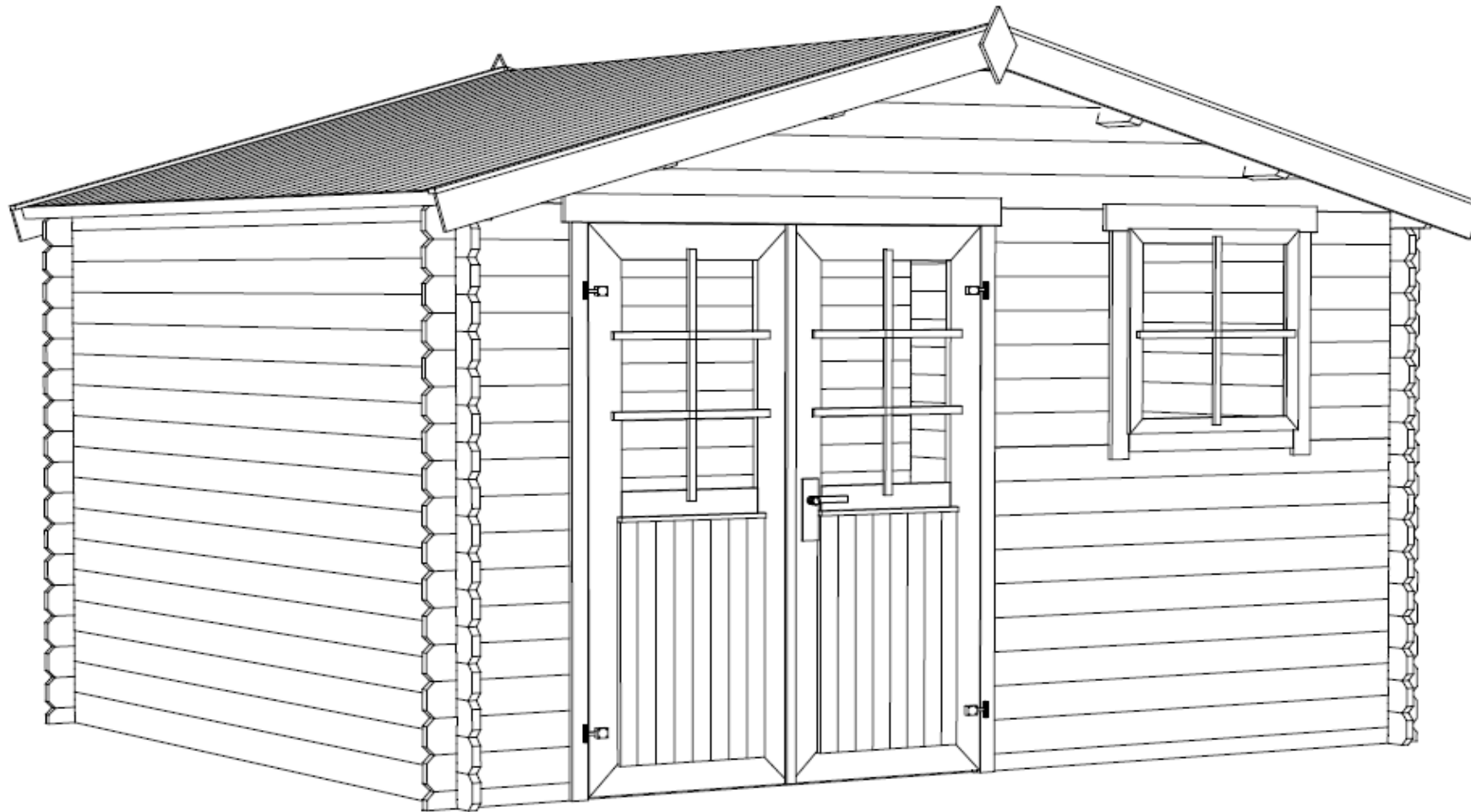

23.10.2023



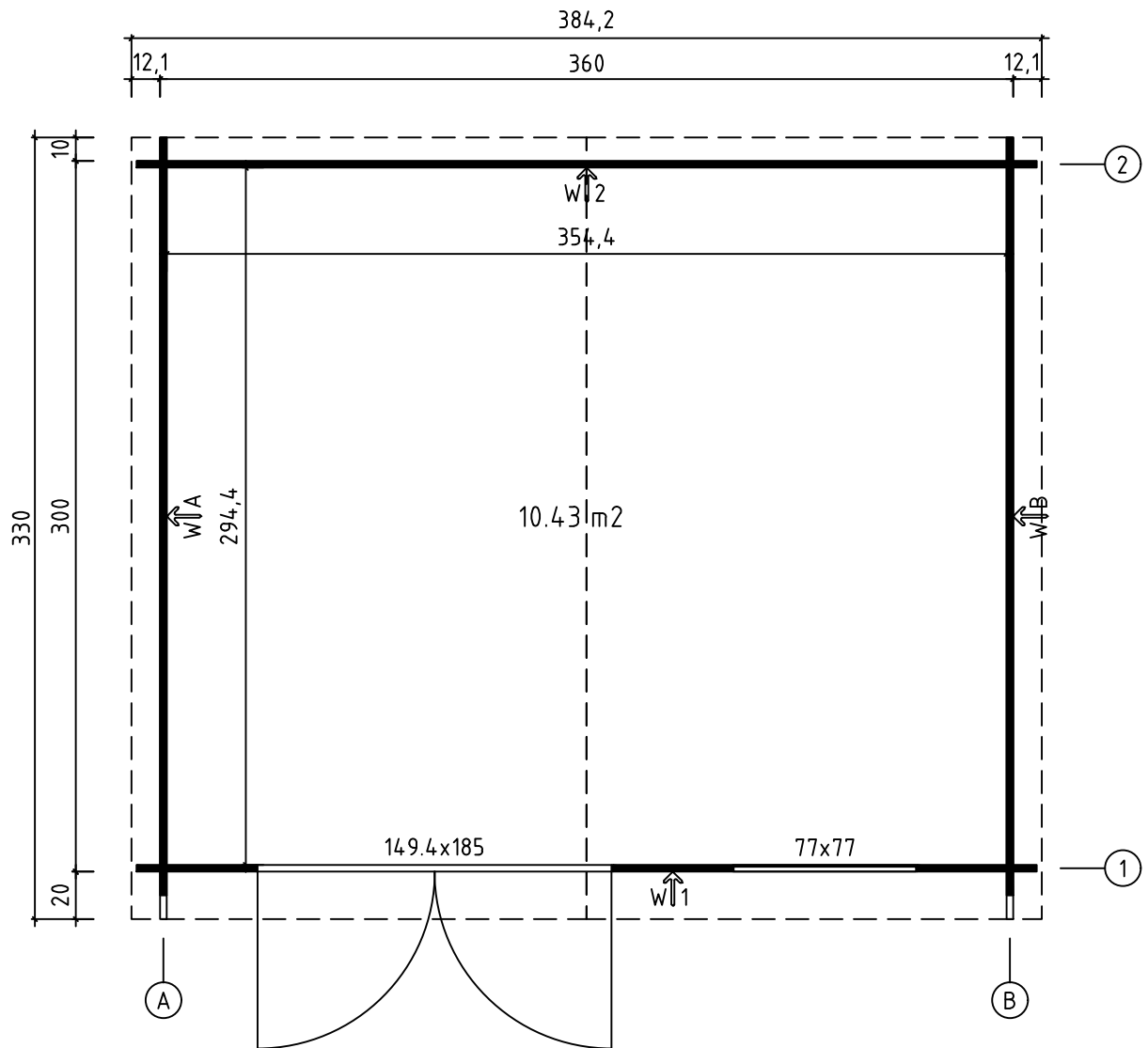

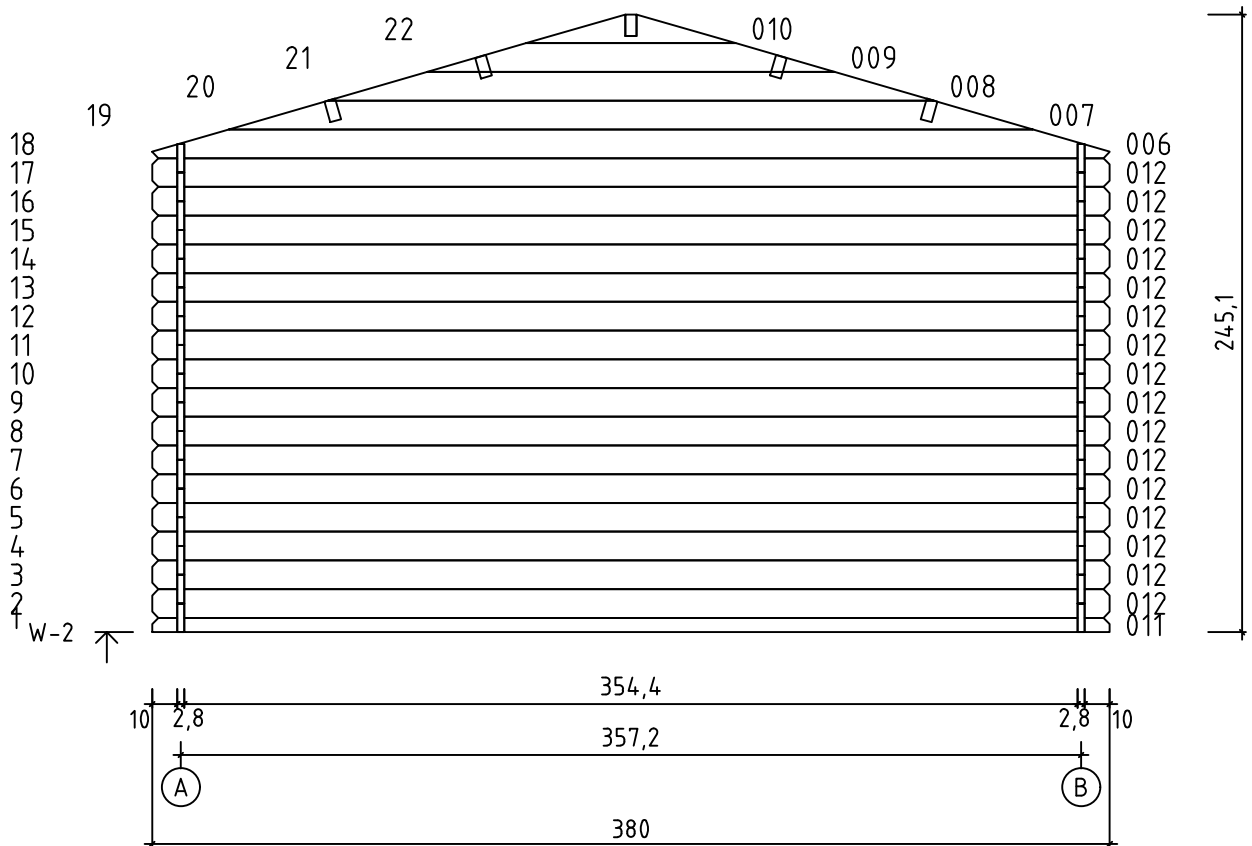
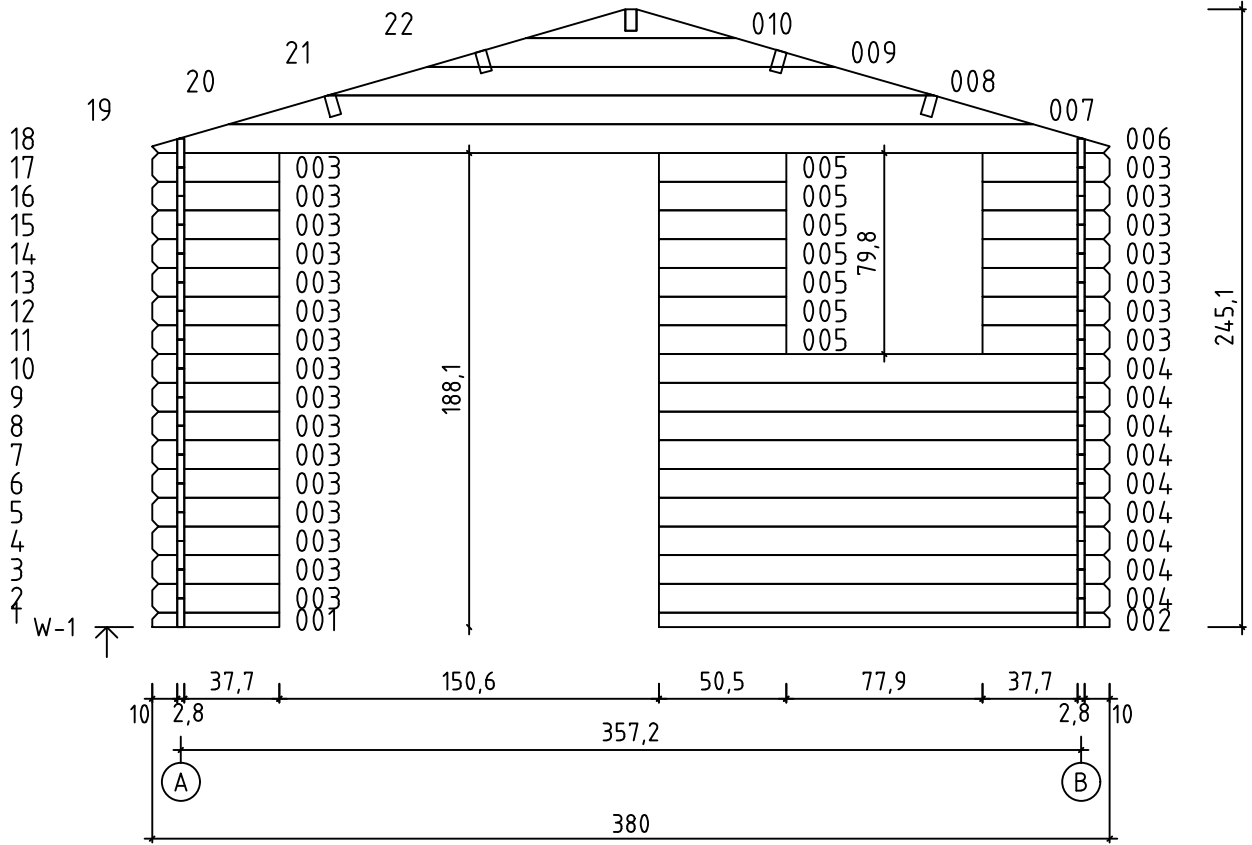

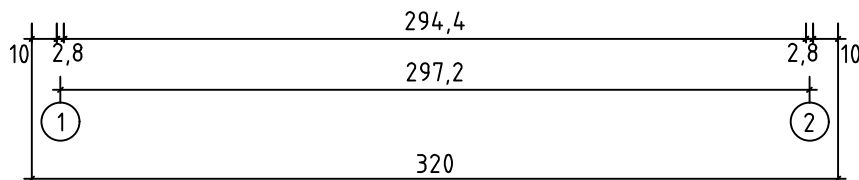
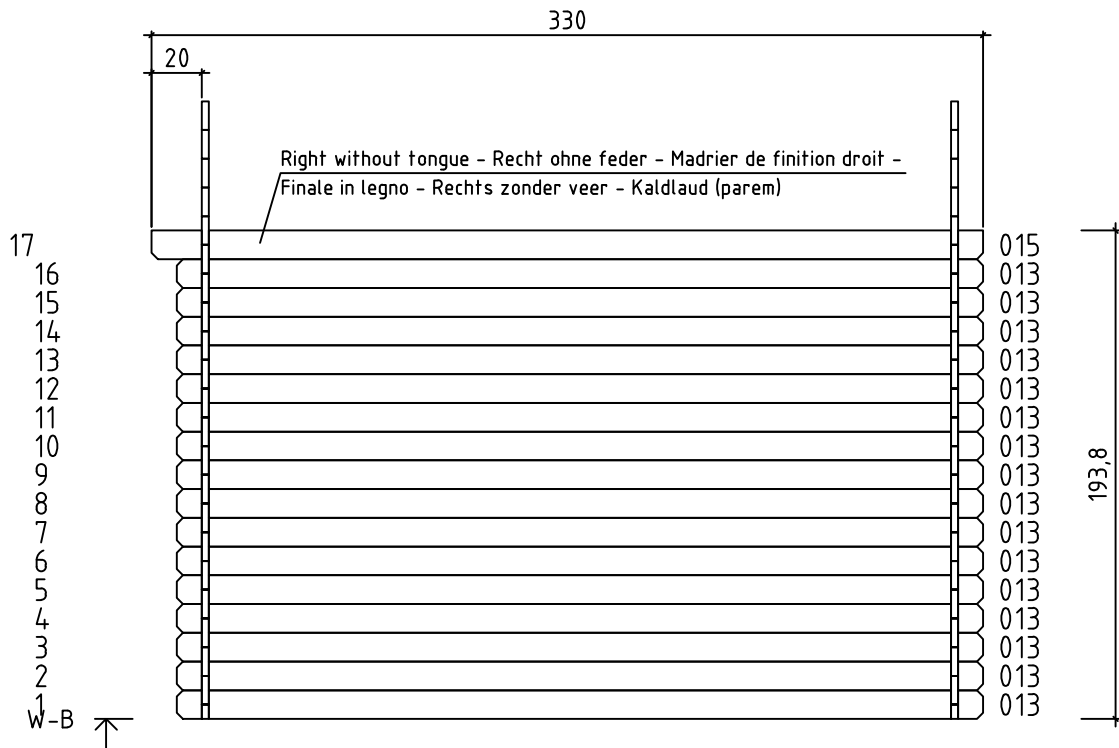
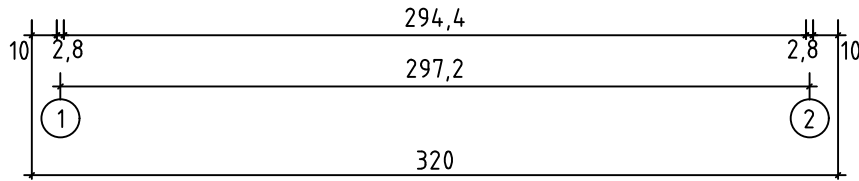
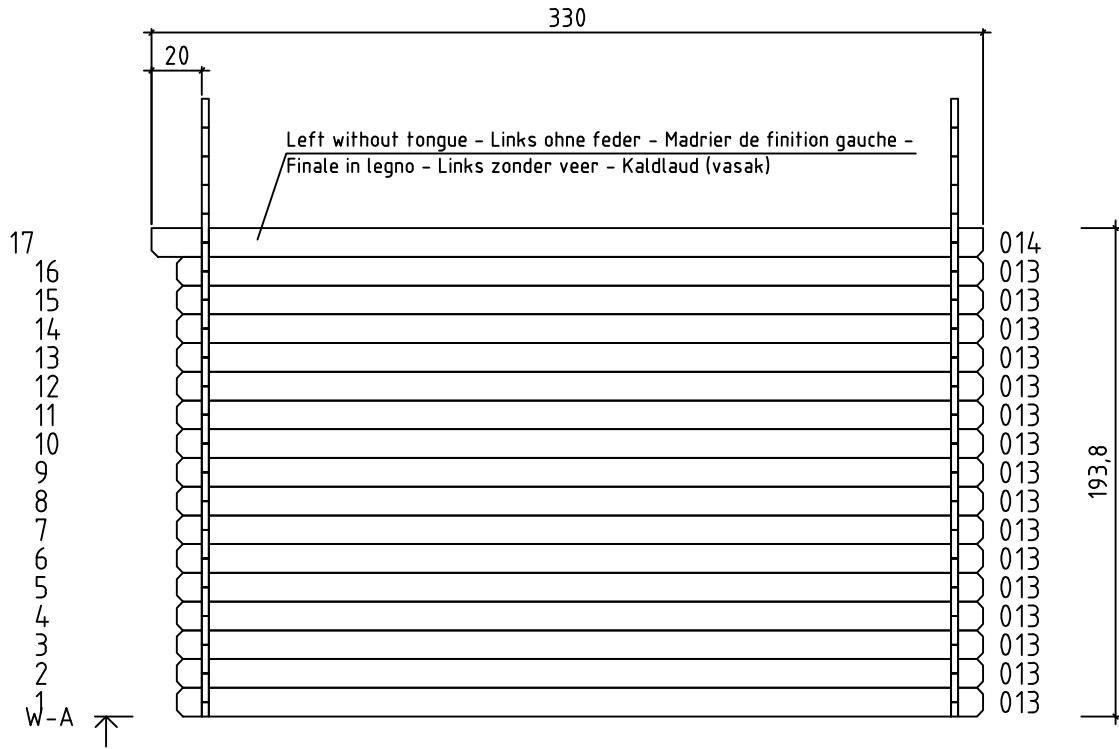

Groundplan - Grundplan - Plan de masse - Planimetria - Plattegrond -
Põhiplaan

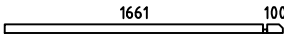

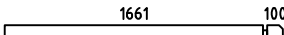

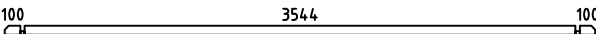
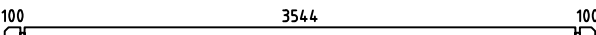
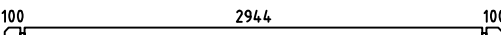
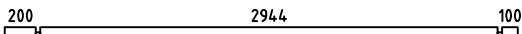
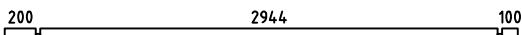
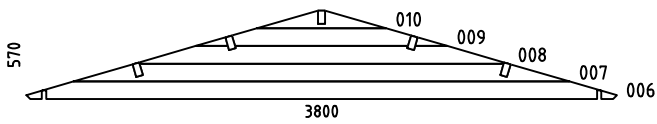
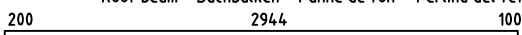



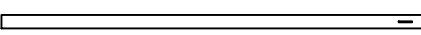
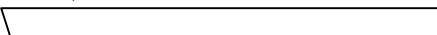
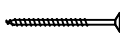
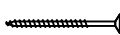
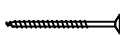
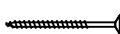

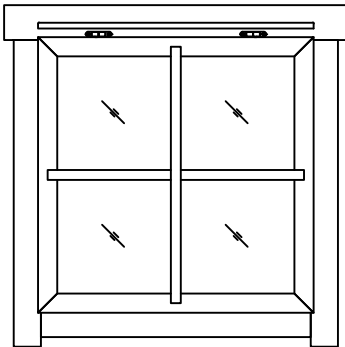
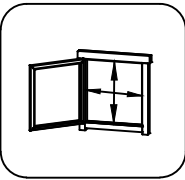
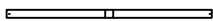
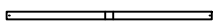

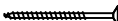



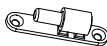
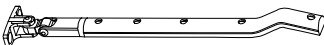

Art. Nr. 2810296

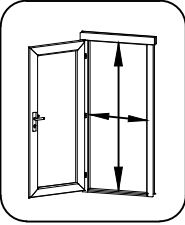
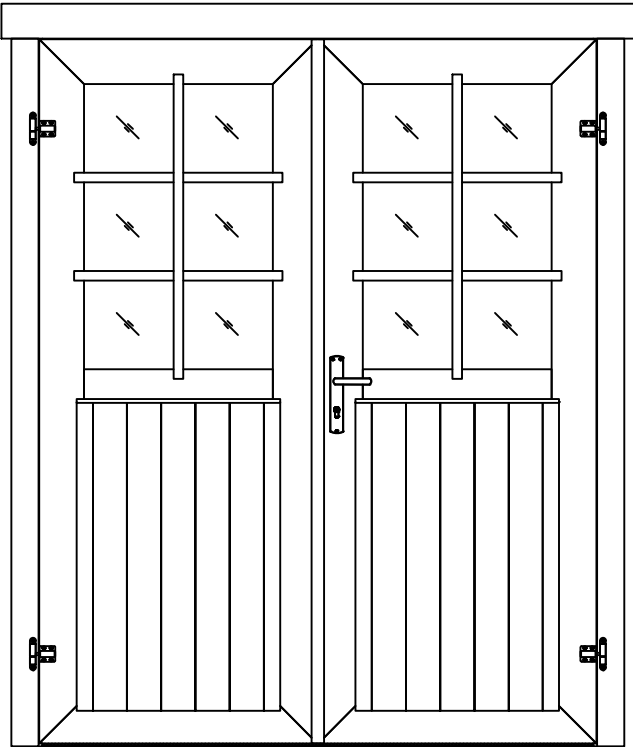

Pos	23.10.2023 Piece list - Stückliste - Liste des pièces - Elementi - Stuklijst - Tükitalabel Art. Nr. 2810296 5/6	Q	P (mm)	L (mm)
001		1	28x57	505
002		1	28x57	1789
003		23	28x114	505
004		9	28x114	1789
005		7	28x114	505
011		1	28x57	3800
012		16	28x114	3800
013		32	28x114	3200
014		1	28x120	3300
015		1	28x120	3300
W1-1 W2-1		1 1		
A-PR1	Roof beam - Dachbalken - Panne de toit - Perlina del tetto - Gordingen / dakbalk - Pärilin 	5	44x120	3300
	Roof boards - Dachbretter - Voliges - Perlina per tetto - Dakhout - Katuselaud 	74	90x15,5	2000
	Roofing felt fillet - Dachpappenleiste - Baguette de fixation du feutre bitumeux - Asse per fissaggio guaina bituminosa - Afdekljst asfaltpapier - Katussepapiliist 	4	15x45	2050
TB-1	Fascia board - Traufbrett - Bandeau de toit - Finitura lati tetto - Gevellijst - Räästalaud 	2	15x45	3300
KFS-1	Storm protection - Sturmleiste - Latte anti-tempete - Protezione anti vento - Stormverankering / beveiliging - Tormikinnitusliist 	4	22x45	2050
	Gable moulding - Giebelleiste - Planche de rive - Finitura per frontale e retro del tetto - Gevellijst - Viilulaud 	4	15x120	2050
HS8	Screw for gable segment - Schrauben für deckblatt - Vis pour fixation losange de finition - Viti x frontali tetto - Schroef voor gevelpunt segment - Kruvi rombile 	4	3.5x35	
HS9	Screw for gable moulding - Schrauben für giebelleiste - Vis pour fixation planche de rive - Vite per fissare finiture davanti e dietro del tetto - Schroef voor gevellijst - Kruvi viilulauale 	32	3.5x50	
HS12	Screw for fascia boards - Schrauben für traufbretter - Vis pour fixation bandeau de toit - Viti x striscia del tetto - Schroef voor gevellijst - Kruvi räästalauale 	16	4x40	
HS18	Screw for gable - Schrauben für giebel - Vis pour fixation des pignons - Viti per timpano - Schroef voor gevelpunt - Kruvi kelba kinnitamiseks 	4	5x120	

Pos	14.03.2018	Piece list - Stückliste - Liste des pièces - Elementi - Stuklijst - Tükítabel 770x770 AK.1.104.SVA.c SGA	1/1	Q	P (mm)	L (mm)
		Glass size - Glasgröße - Taille de la vitre - Misura del vetro - Glas afmeting - Klaasi mõõt: 626x626 mm			670x670 mm	
1	Georgian bars - Sprossen - Croisillons - La griglia georgiana - Raamverdeling - Petteliistud		1	15x25	660	
2	Georgian bars - Sprossen - Croisillons - La griglia georgiana - Raamverdeling - Petteliistud		1	15x25	660	
3	Batten - Deckleiste - Profils de finition angles a l'exterieur - Asse Afdek lijst - Katteliist		1	15x25	710	
HS1	Screw for georgian bars - Schraube für sprossen - Vis pour croisillons - Viti per unire la griglia georgiana della finestra - Schroeven voor raamverdeling - Kruvi akna petteliistule		4	2.5x20		
HS10	Screw for window hinge - Schraube für fenster scharnier - Vis pour Fenetre charniere - Viti per cerniera a finestra - Schroef voor raam scharnier - Kruvi akna polthingele		4	4x25		
HS10	Screw for window fixator - Fensterfixierung - Fenžtre fixator - Vite per fissatore di finestra - Schroef voor raambevestiger - Kruvi akna fiksaatorile		6	4x25		
NF2	Zn nail - Zn nägel - Pointe - Chiodi - Nagel - Nael		5	1.4x40		
NA1	Hinge for window - Scharnier für fenster - Charniere pour fenetre - Cerniere per Finestra - Raam scharnier - Aknahing		2			
NA2	Hinge for window - Scharnier für fenster - Charniere pour fenetre - Cerniere per Finestra - Raam scharnier - Aknahing		2			
NA3	Window fixator - Fensterfixierung - Fenžtre fixator - Fissatore della finesra - Raam(ver)dichting - Akna fiksaator		1			
NA4	Window fixator - Fensterfixierung - Fenžtre fixator - Fissatore della finesra - Raam(ver)dichting - Akna fiksaator		1			
NA5	Window fixator - Fensterfixierung - Fenžtre fixator - Fissatore della finesra - Raam(ver)dichting - Akna fiksaator		1			

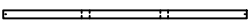
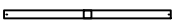
Pos	19.12.2017	Piece list - Stückliste - Liste des pièces - Elementi - Stuklijst - Tükítabel 14 94x1850 TUK.2.056.SVP.MMX28 SGA+28	1/2	Q	P (mm)	L (mm)
Glass size - Glasgröße - Taille de la vitre - Misura del vetro - Glas afmeting - Klaasi mõõt: 502x750 mm				 <p>1418x1794 mm</p>		
						
1	Upper door jamb - Türrahmen oben - Cadre de porte supérieur - Telaio superiore della porta - Bovendorpel - Ukse ülemine leng			1	66x100	1628
2	Left door jamb - Türrahmen links - Cadre de porte gauche - Telaio montante sinistro della porta - Linkerstijl deurframe - Ukse vasak leng			1	66x80	1850
3	Right door jamb - Türrahmen rechts - Cadre de porte droit - Telaio montante destro della porta - Rechterstijl deurframe - Ukse parem leng			1	66x80	1850
4	Doorstep - Swelle - Barre de seuil - Soglia della porta - Deurdorpel - Lävepakk			1	20x21	1418
5	Connection strip - Deckleiste - Baguette de battement - Profilo verticale della porta - Stulplijst - Kokkuvalltsiliist			1	13x32	1812
6	Georgian bars - Sprossen - Croisillons - La griglia georgiana - Raamverdeling - Petteliistud			2	15x25	784
7	Georgian bars - Sprossen - Croisillons - La griglia georgiana - Raamverdeling - Petteliistud			4	15x25	536

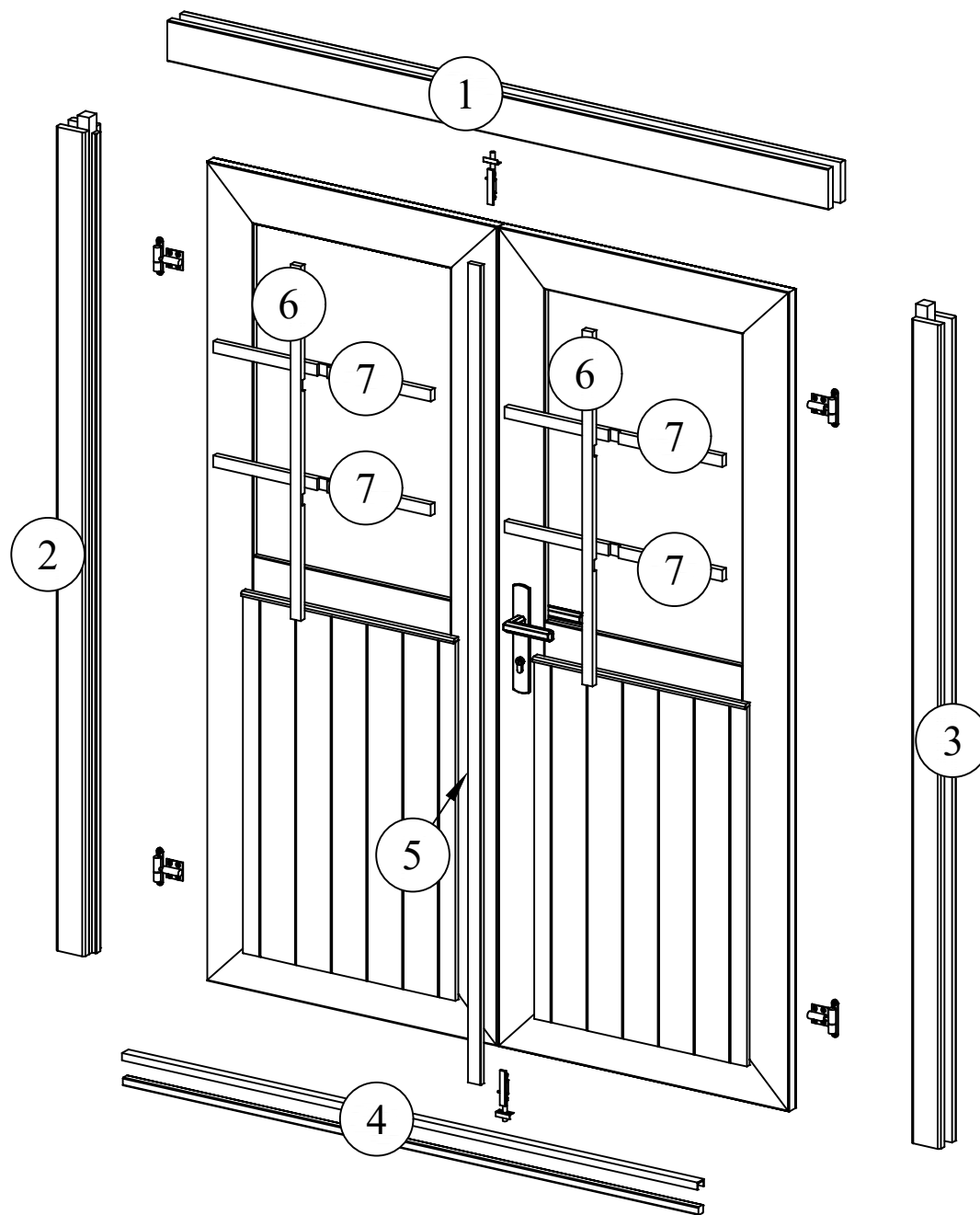

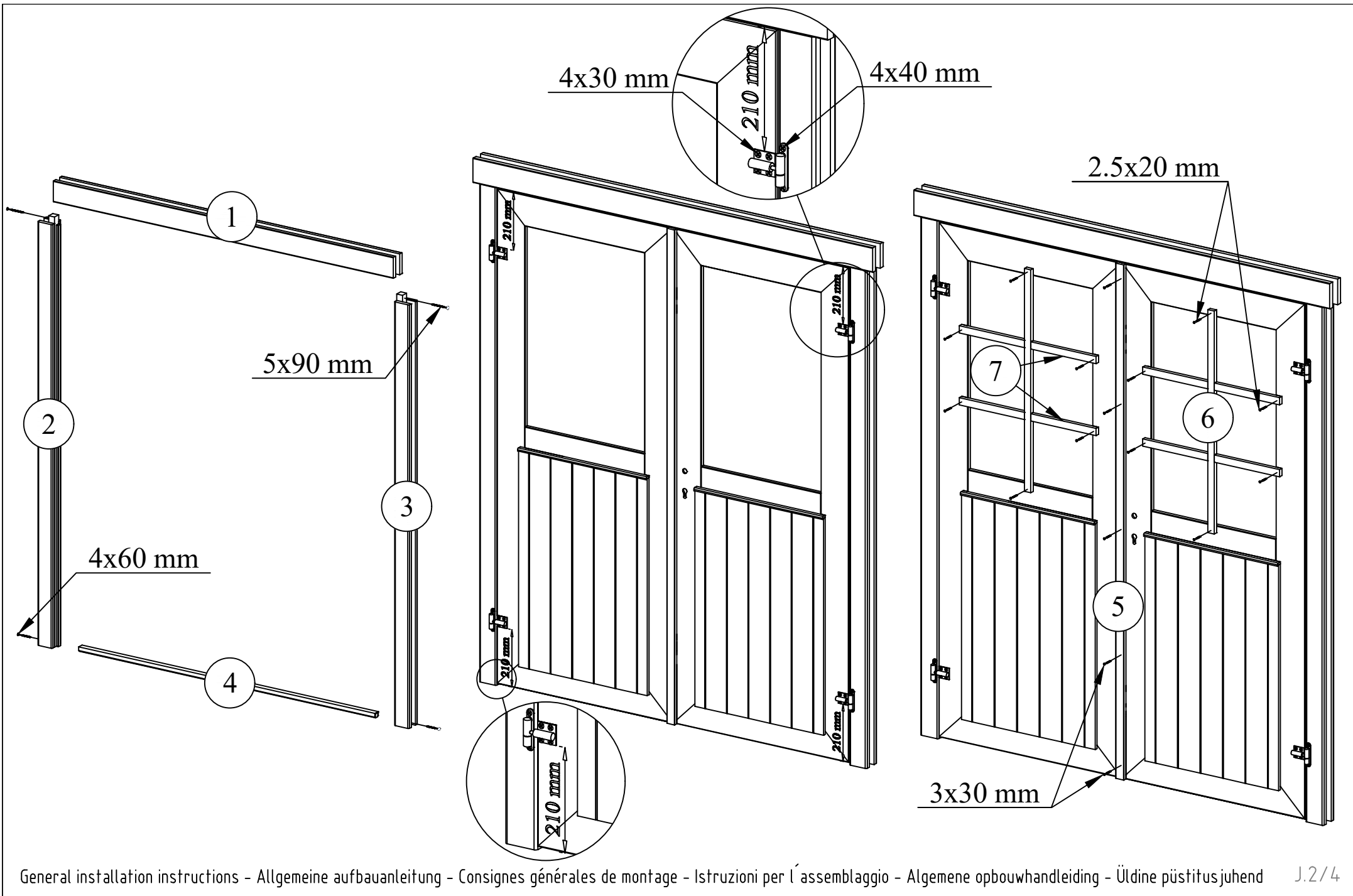

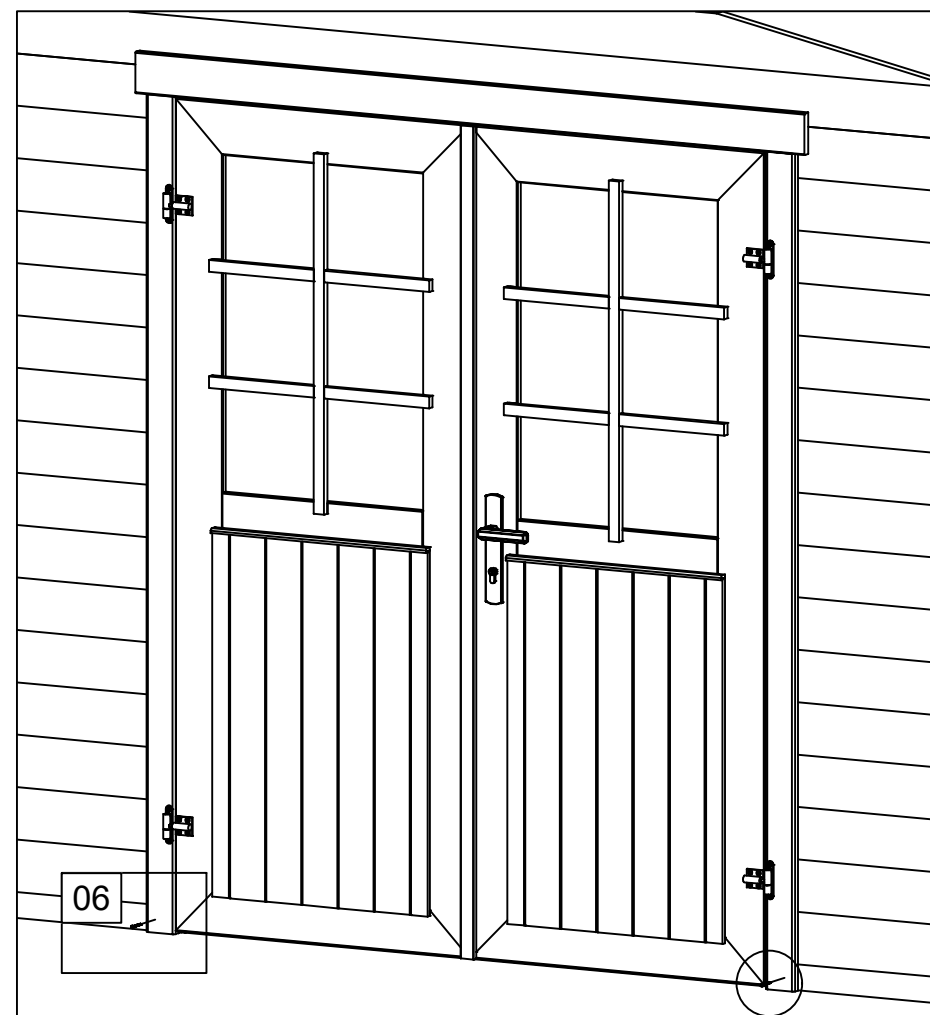
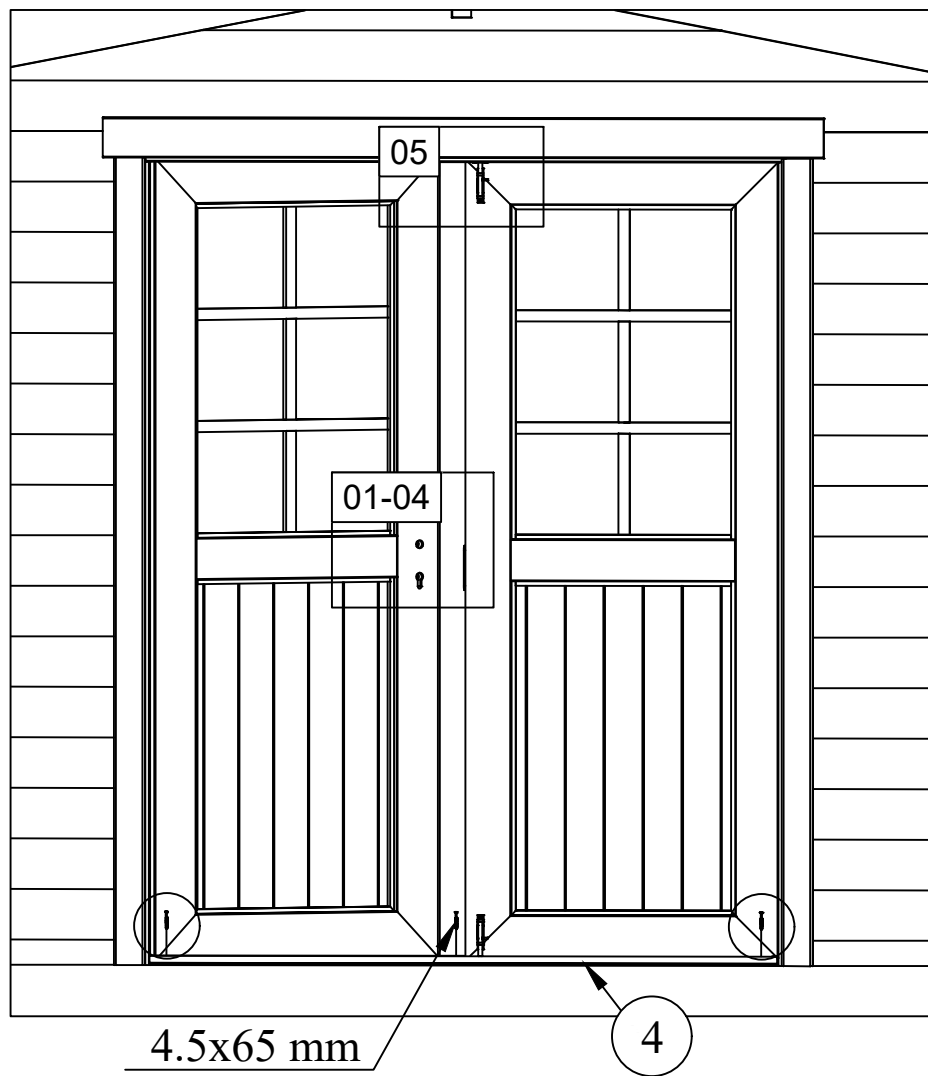

01

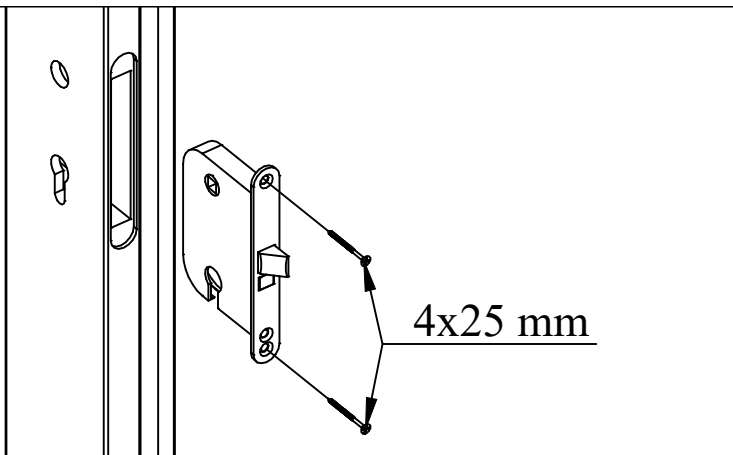

04

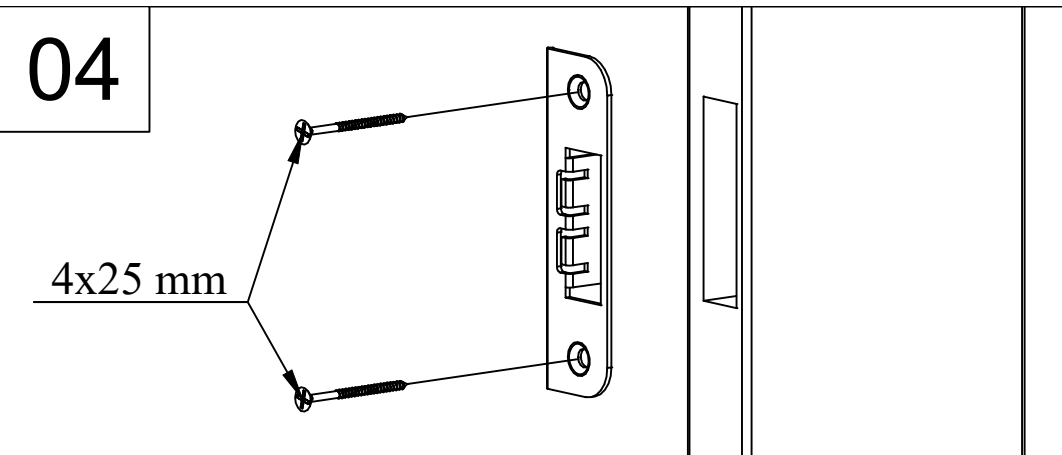

02

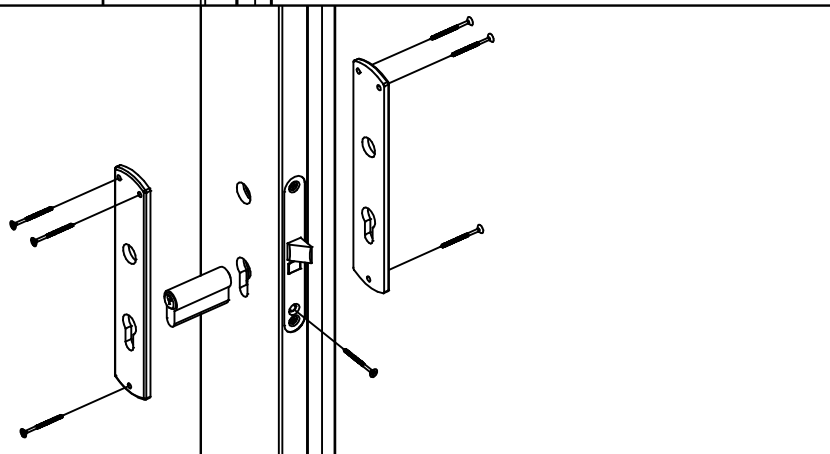

05

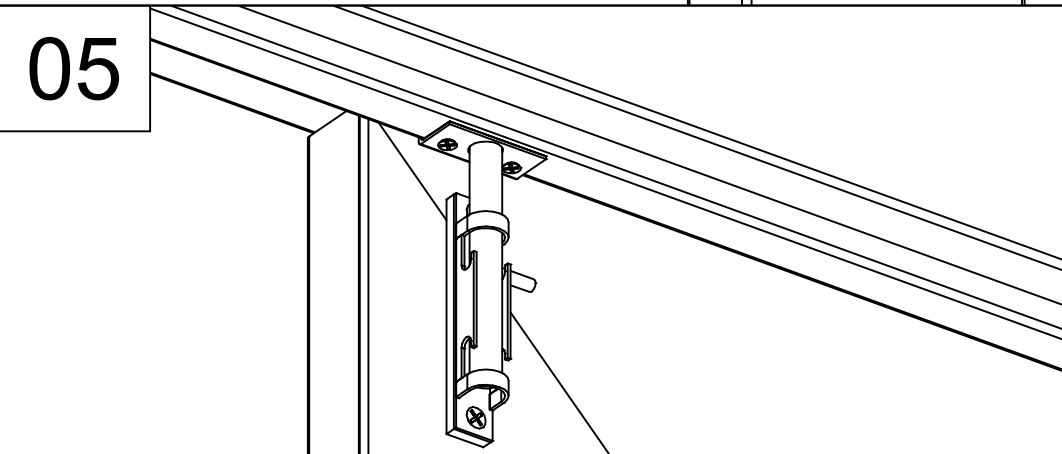

03

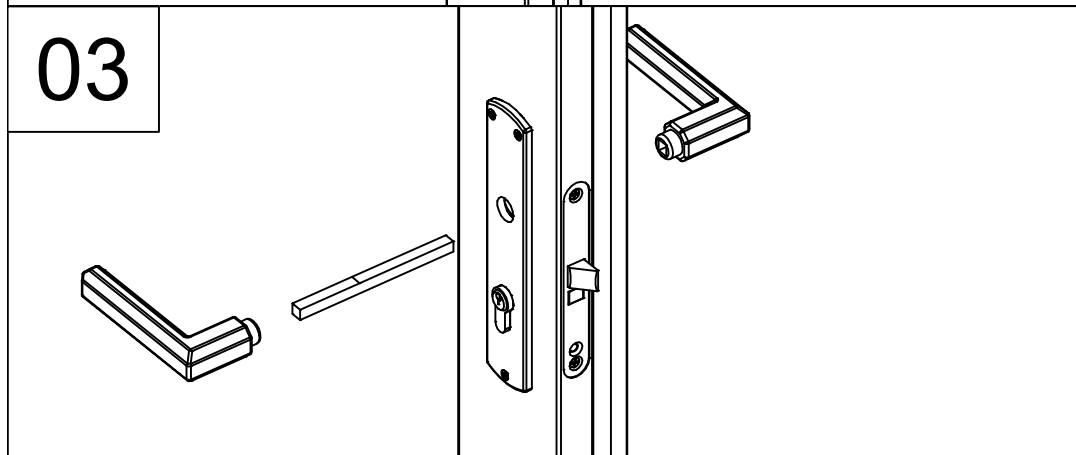

06

